











Standard Unit Dimensions:

Bespoke size options

Colours/Finishes:

 Galvanised Only	 RAL 9006 White Aluminium	 RAL 7016 Anthracite Grey
 BS 4800 10 A 07 Nimbus Grey	 RAL 3020 Traffic Red	 RAL 9005 Jet Black
 BS 4800 14 C 39 Holly Green	 RAL 1023 Traffic Yellow	 BS 4800 00 A 05 Goose Grey
 RAL 5015 Mid Blue	 RAL 5013 Dark Blue	 RAL 9016 Traffic White

The colours shown are a guide only.
Please check a colour chart to see the actual colour.

Product Information

This single unit shelter may be used as an economical alternative to any ground based smoking & vaping shelter and can also be situated above any doorway or entrance to provide shelter.

Features

- PET cladding to roof
- Galvanized mild steel framework
- Choice of end panels

Materials Used

- PET cladding to roof
- Galvanized mild steel framework

Finish Options

- Hot dip galvanised to BS EN ISO 1461:2009
- Polyester powder coated paintwork in 19 RAL colours

Weather Resistance

Cladding is UV Stabilised
Wind resistant to 23m/s

Broxap Limited, Rowhurst Industrial Estate, Chesterton, Newcastle-under-Lyme, Staffordshire, ST5 6BD T: 01782 564411 E: info@broxap.com W: www.broxap.com



ISO 9001
Quality Management Systems
CERTIFIED

ISO 14001
Environmental Management
CERTIFIED

ISO 45001
Occupational Health and Safety Management
CERTIFIED



Fire Resistance

Cladding is fire tested to '1Y' for BS 476

Guarantees, Warranties, Design-Life and Life-Expectancies

- 25 year structural guarantee*
- 34 year (min) life expectancy for Hot Dip Galvanizing
- 8-10 year life expectancy on standard powder coatings
- 10-15 year life expectancy on Duplex (Zinc Coated) powder coatings
- 10 years' manufacturers guarantees* on cladding material(s)
- 10 years' warranty* on material (only)
- 12 months' warranty* on parts & labour

*Maintenance and other qualifying criteria apply

Options

- Internal lighting or solar lighting
- Polyester powder coated steelwork
- Installation service available

Diagram

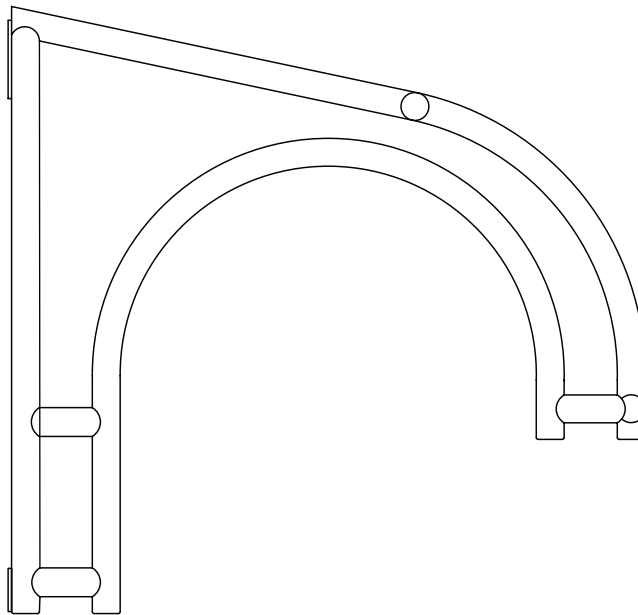

Standard Unit Dimensions:

Bespoke size options

Colours/Finishes:

Galvanised Only	RAL 9006 White Aluminium	RAL 7016 Anthracite Grey
BS 4800 10 A 07 Nimbus Grey	RAL 3020 Traffic Red	RAL 9005 Jet Black
BS 4800 14 C 39 Holly Green	RAL 1023 Traffic Yellow	BS 4800 00 A 05 Goose Grey
RAL 5015 Mid Blue	RAL 5013 Dark Blue	RAL 9016 Traffic White

The colours shown are a guide only. Please check a colour chart to see the actual colour.

Broxap Limited, Rowhurst Industrial Estate, Chesterton, Newcastle-under-Lyme, Staffordshire, ST5 6BD T: 01782 564411 E: info@broxap.com W: www.broxap.com

